

Unit 1 Lesson 8: Formula for the Area of a Triangle

1 Bases and Heights of a Triangle (Warm up)

Student Task Statement

Study the examples and non-examples of **bases** and **heights** in a triangle.

- Examples: These dashed segments represent heights of the triangle.

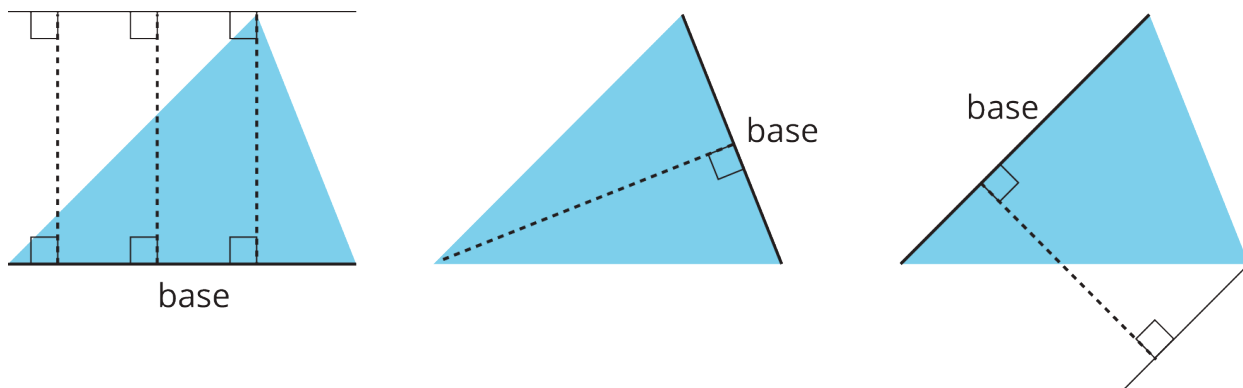

- Non-examples: These dashed segments do *not* represent heights of the triangle.

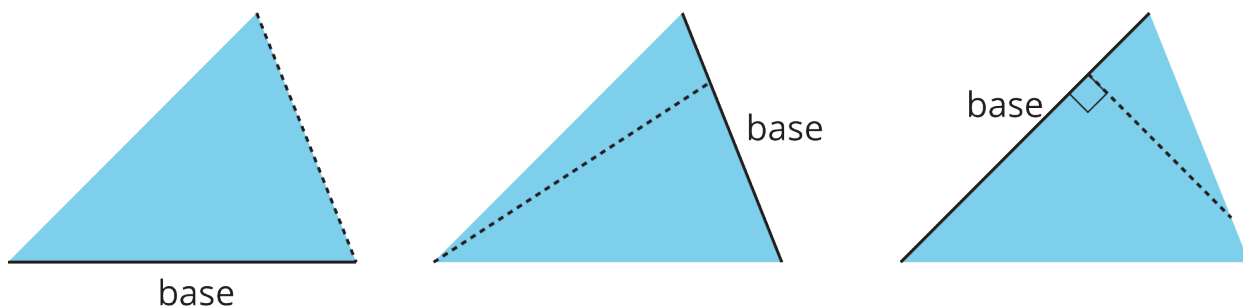

Select **all** the statements that are true about bases and heights in a triangle.

1. Any side of a triangle can be a base.
2. There is only one possible height.
3. A height is always one of the sides of a triangle.
4. A height that corresponds to a base must be drawn at an acute angle to the base.
5. A height that corresponds to a base must be drawn at a right angle to the base.
6. Once we choose a base, there is only one segment that represents the corresponding height.
7. A segment representing a height must go through a vertex.

2 Finding a Formula for Area of a Triangle

Student Task Statement

For each triangle:

- Identify a base and a corresponding height, and record their lengths in the table.
- Find the area of the triangle and record it in the last column of the table.

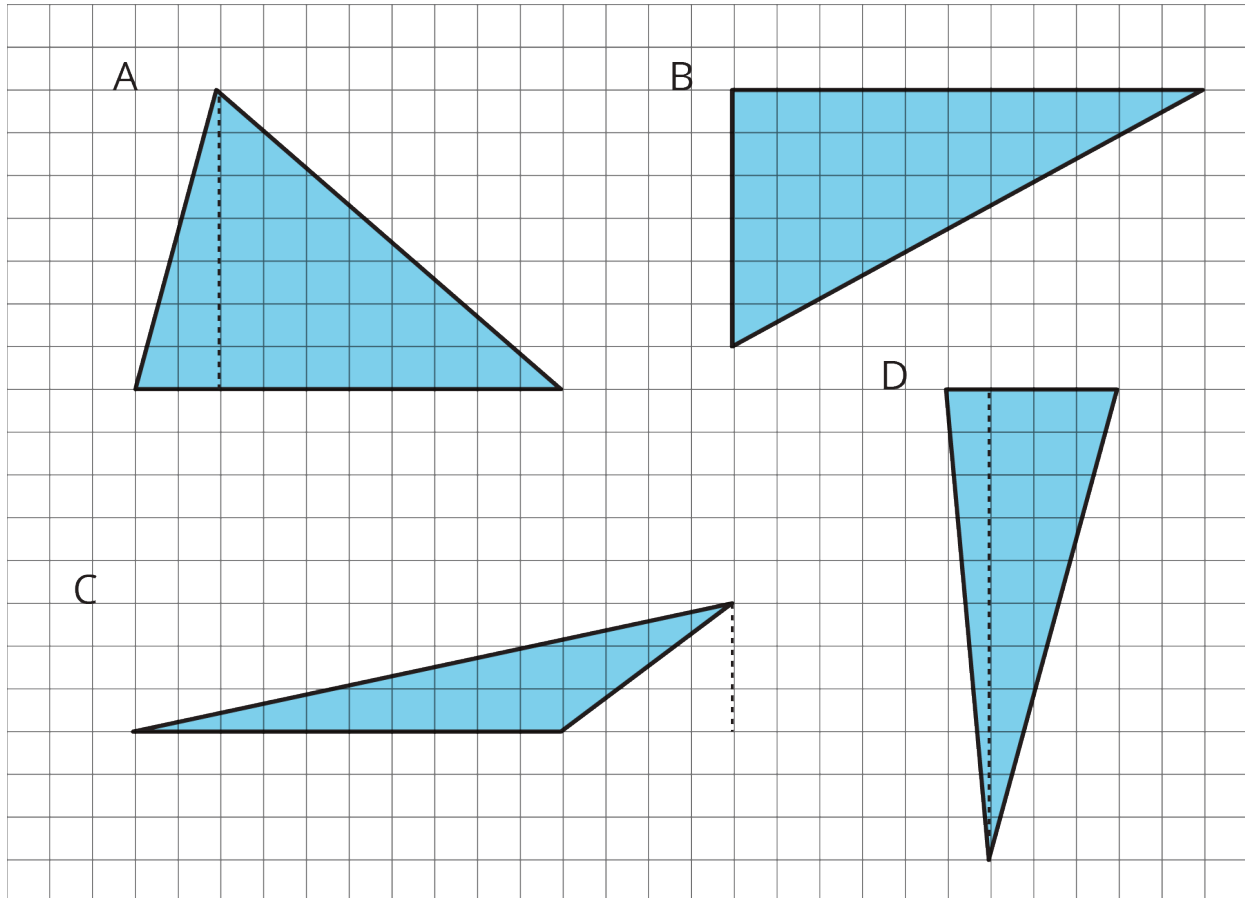

triangle	base (units)	height (units)	area (square units)
A			
B			
C			
D			
any triangle	b	h	

In the last row, write an expression for the area of any triangle, using b and h .

Activity Synthesis

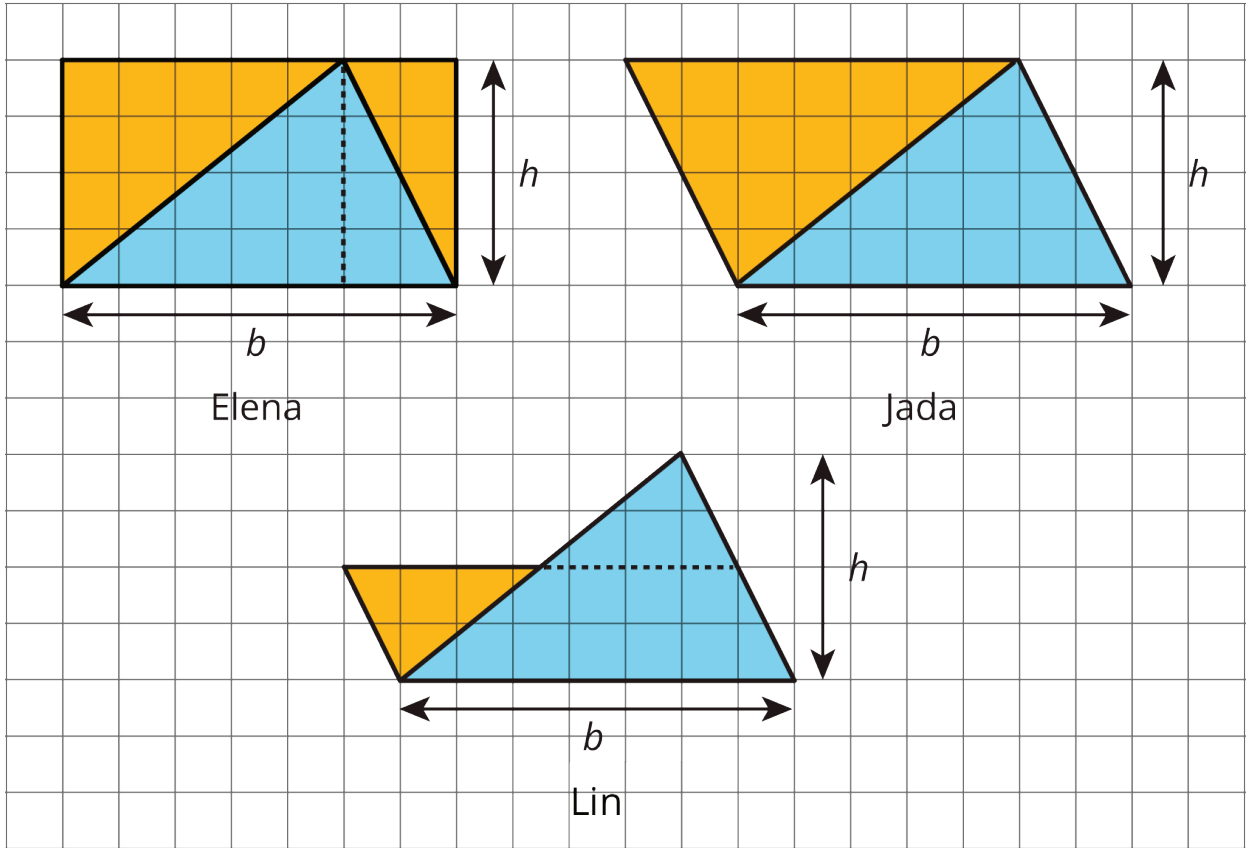

3 Applying the Formula for Area of Triangles

Student Task Statement

For each triangle, circle a base measurement that you can use to find the area of the triangle. Then, find the area of any *three* triangles. Show your reasoning.

A

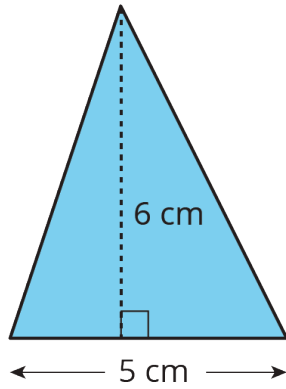

B

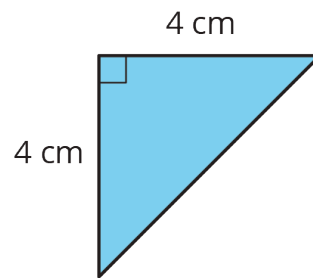

C

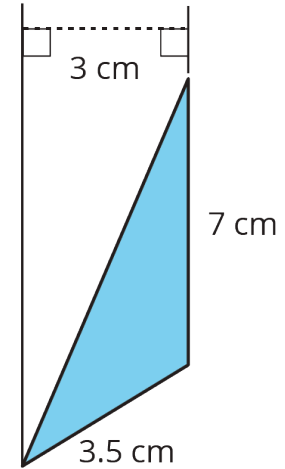

D

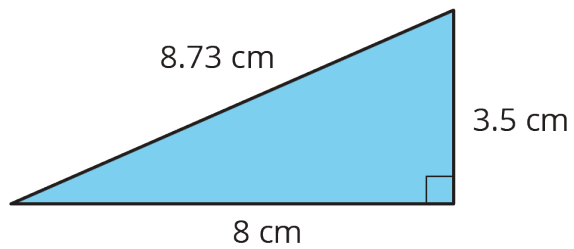

E

